

OPCJA



Kod 5090.1111



Kod 5090.1110

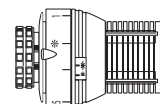

Kod 5090.1119



Kod 5094.425

Kod 5094.427

Kod 5090.1111

Standard

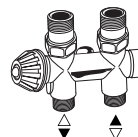
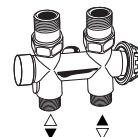

Złącza do instalacji znajdziesz w katalogu Jaga
www.jaga.com.pl

UWAGA

Aby zagwarantować moc grzejnika Jaga zaleca stosować rurki o średnicach 16/2, 18/1 or 18/2.

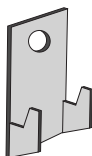

x 4



Ze względów bezpieczeństwa kotki rozporowe nie są dostarczane w komplecie. Dobierz odpowiednie kotki do swojej ściany.

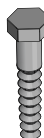

x 4

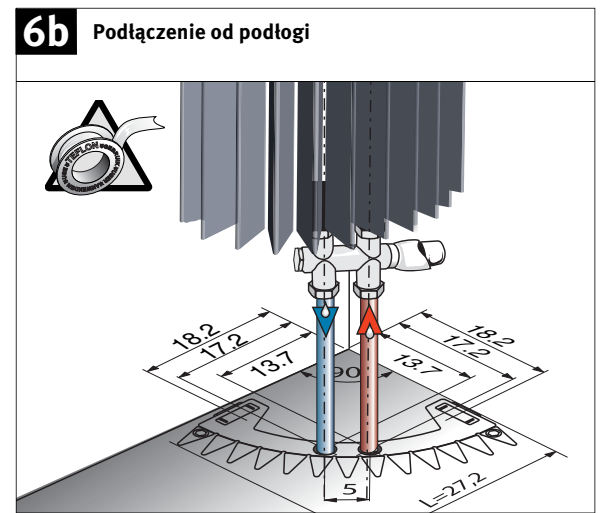
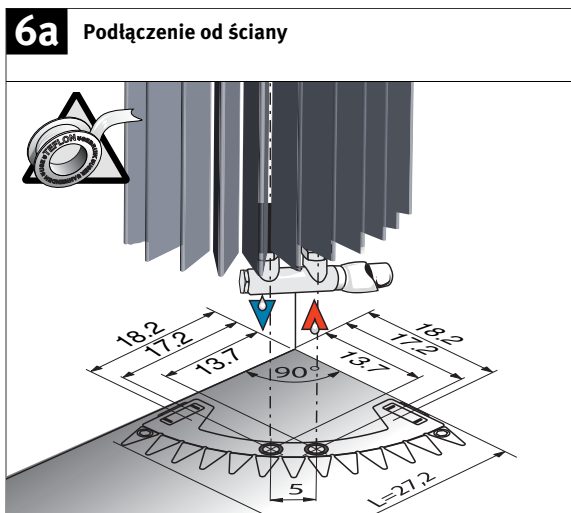
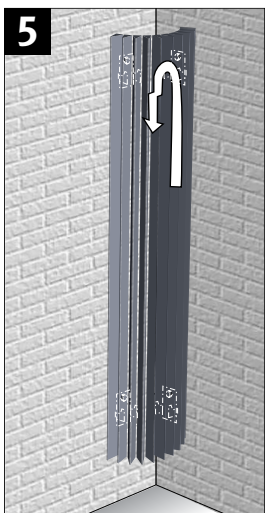
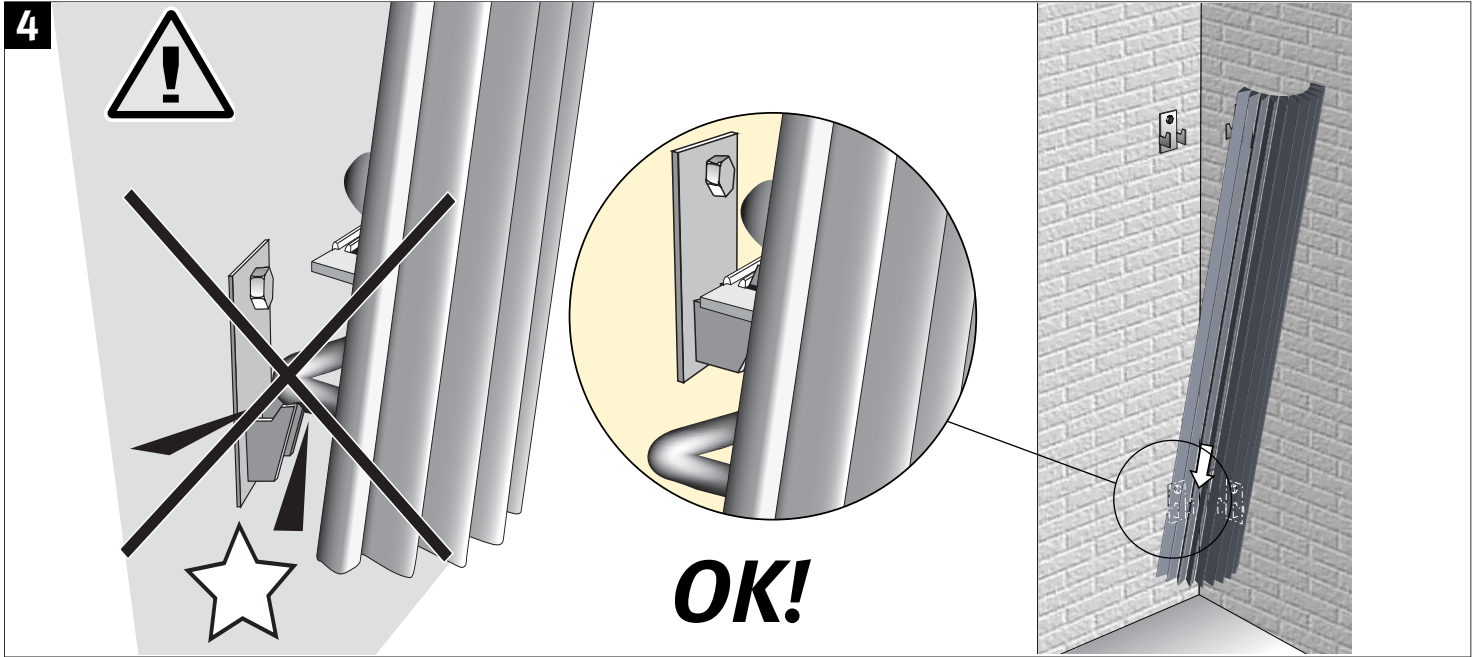
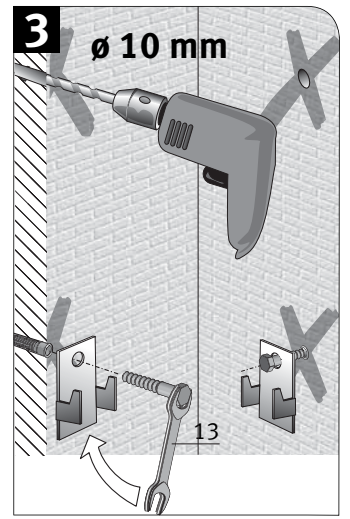
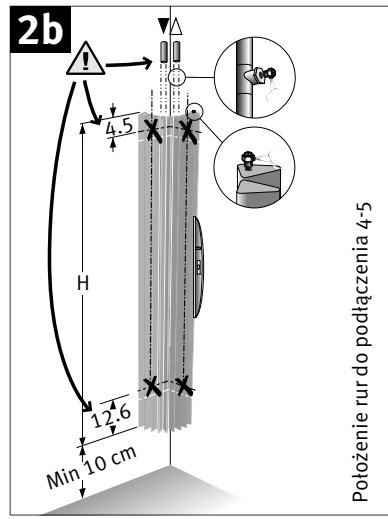
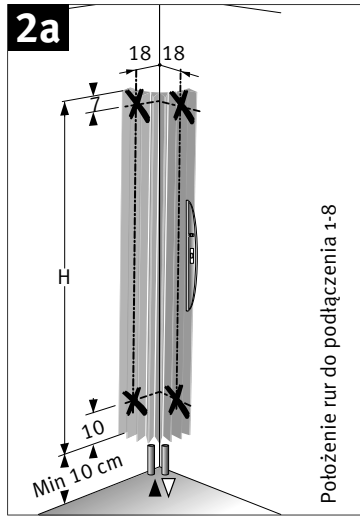
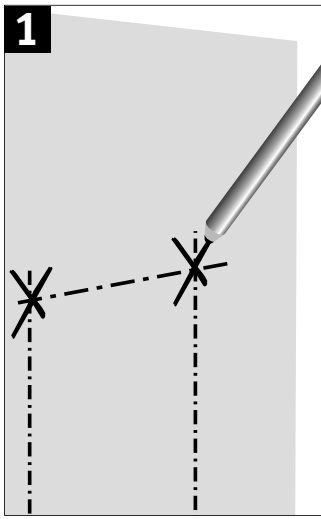

Podłączenie do instalacji jedno- lub dwururowej

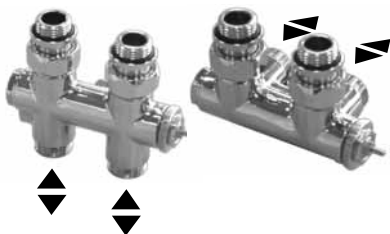

Zasilanie z prawej lub lewej strony, niezależne od pozycji głowicy termostaticznej.

